

Article number: 604145030040

Description: Timing belt pulley with hub  
HTD 30 14M 40

## Measures

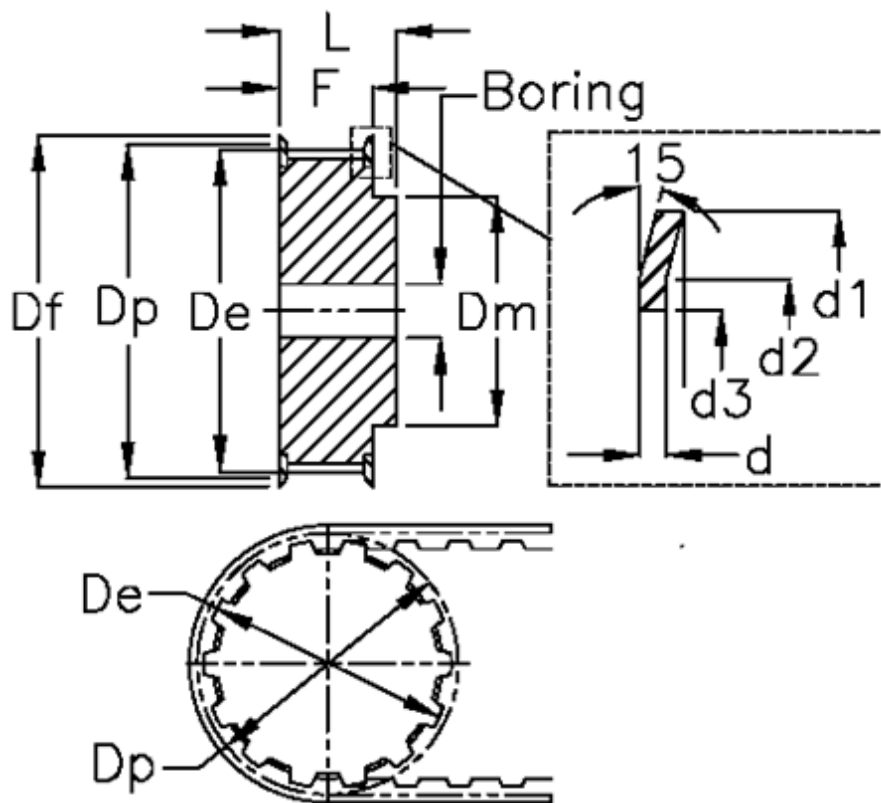

Bore = 24	Dp	= 133.69
d = 2.5	F	= 54
d1 = 138	Flange type	= F43
d2 = 132	L	= 69
d3 = 121	Tooth number	= 30
De = 130.99	Type	= 14M
Df = 138	Weight	= 5.45
Dm = 100	Width	= 40